

# How it works

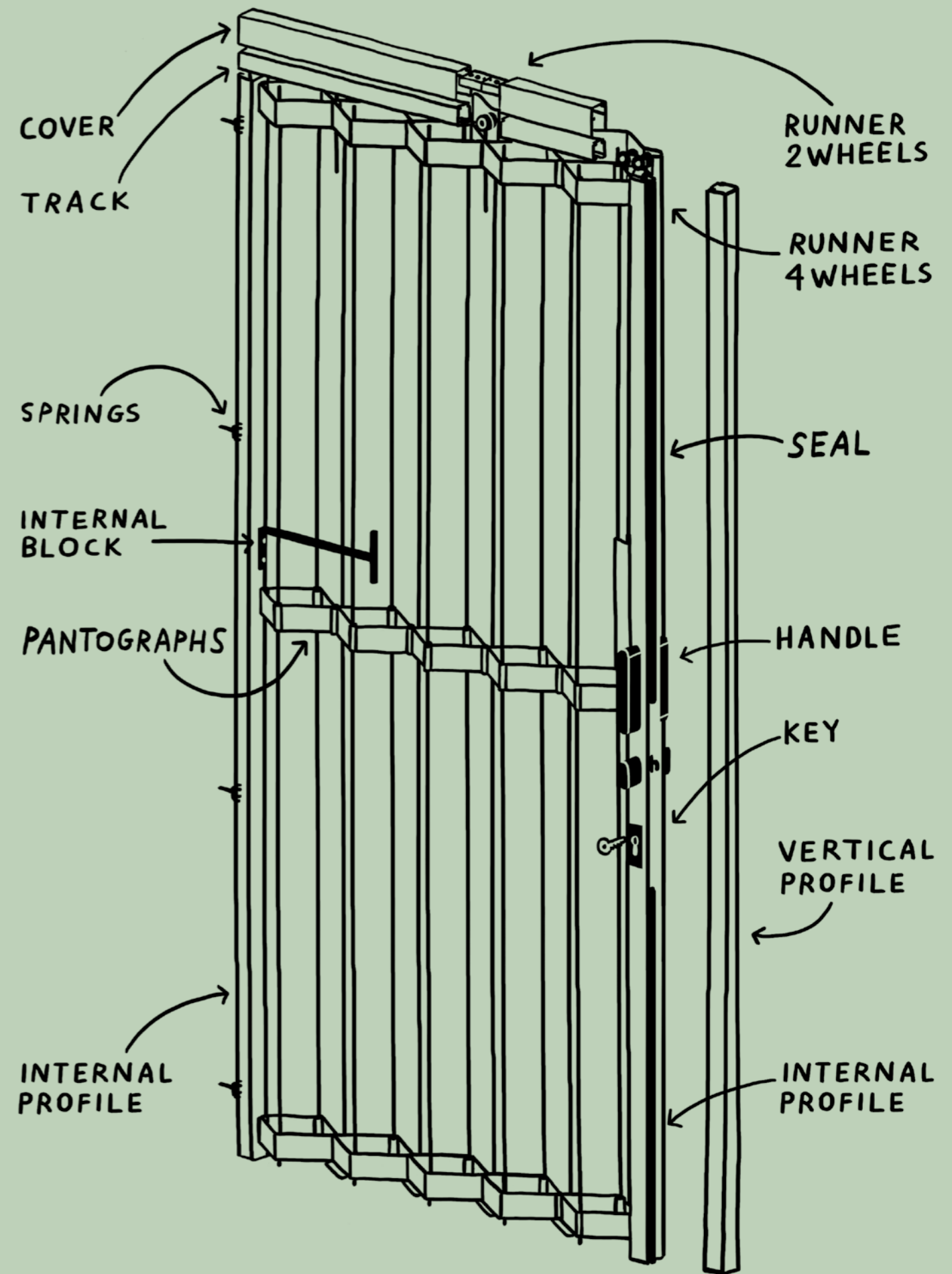

## Caratteristiche del prodotto

## Product Features

### Composizione, altezza e larghezza

### Composition, height and width

Le partizioni tessili Door hanno una struttura metallica a fisarmonica composta da pantografi, tondini e profili. Quest'anima interna robusta e flessibile è ricoperta con un rivestimento da entrambe i lati. Lo scorrimento delle porte nella guida superiore avviene tramite carrelli con cuscinetti a sfera.

L'altezza delle porte è pari all'altezza del vano in cui la porta va inserita, con una luce dai 5 ai 10 mm a pavimento, necessari a garantire il corretto scorrimento. L'altezza massima possibile è di 6000 mm. Grazie a un sistema di giunzione tra più moduli, le pareti tessili Door non hanno limiti in larghezza e raggiungono ampiezze potenzialmente infinite.

Door textile partitions feature an accordion-style metal framework composed of pantographs, rods, and profiles. This robust yet flexible internal core is covered with cladding on both sides. The doors slide within the upper track by means of ball-bearing runners.

The door height corresponds to the structural opening height, with a floor clearance of 5 to 10 mm to ensure smooth operation. The maximum achievable height is 6000 mm. Thanks to a modular coupling system, Door textile walls have no width restrictions, reaching potentially infinite spans.

### Porta tessile Door Door textile folding door

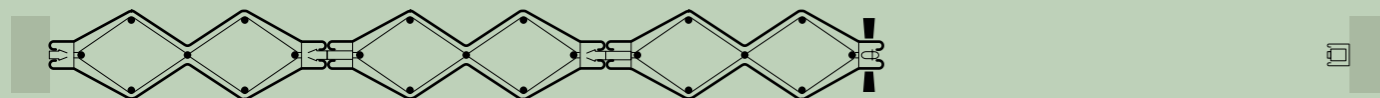

La larghezza di ogni singolo modulo va ricercata all'interno della tabella di costruzione sottostante.

The widths of each single module may be found in the specifications table below.

Tabella di costruzione dei moduli (larghezze fisse di prodotto in mm) Modules specification table (fixed widths in mm)	825		970		1115		2130
	1260	1405	1550	1695	1840	1985	
	2275	2420	2565	2710	2855	3000	3145

### Peso

### Weight

Il peso della porta è di circa 8 kg al mq, variabile in funzione del rivestimento. Ogni singolo modulo che compone le porte tessili Door ha un peso non superiore ai 50 kg, al fine di rendere più agevole l'installazione e la manutenzione. Per porte con peso totale superiore ai 50 kg il sistema di giunzione tra moduli consente di suddividere il peso della porta.

The weight of the door is about 8 kg per square meter, depending on the cladding material. The weight of each single module composing Door textile doors does not exceed 50 kg, so that installation and maintenance are easy to perform. For doors with a total weight of more than 50 kg, the coupling system between modules allows distributing the weight of the door.

## Misure degli ingombri

## Overall dimensions

Le misure degli ingombri delle porte tessili Door differiscono tra porta distesa e porta raccolta. La porta distesa ha uno spessore (A) di circa 180 mm e una larghezza (B) pari alla larghezza del vano. La porta raccolta ha uno spessore (C) che varia tra 220 mm e 240 mm in funzione dello spessore del rivestimento e una larghezza (D) pari a circa il 20% della larghezza del vano se presente un accessorio opzionale di blocco. In assenza di tale accessorio la larghezza (D) sarà pari a circa il 30%. Poiché la porta, non avendo una guida a pavimento, durante il movimento di apertura e chiusura potrebbe oscillare, in caso di posizionamento della stessa in prossimità di arredi o elementi strutturali si consiglia di considerare una distanza dal centro guida (E) di 130 mm; mentre per l'inserimento della porta all'interno di una nicchia si consiglia di considerare uno spessore (F) tra i 260 e i 300 mm, a seconda della situazione.

The overall dimensions of Door textile doors differ based on whether the door is extended or folded. The extended door has a thickness (A) of approximately 180 mm and a width (B) equal to the width of the compartment. The folded door has a thickness (C) that varies between 220 mm and 240 mm depending on the thickness of the cladding and a width (D) that is approx. 20% of the compartment width if an optional block accessory is present. Without this accessory, the width (D) will be approximately 30%. Since the door lacks a floor track and may sway during operation, a minimum clearance of 130 mm from the track centerline (E) is recommended when installed near furniture or structural elements. For installation within a niche, a minimum internal width (F) between 260 and 300 mm is advised, depending on the situation.

### Ingombro porta distesa Overall dimensions of fully extended door

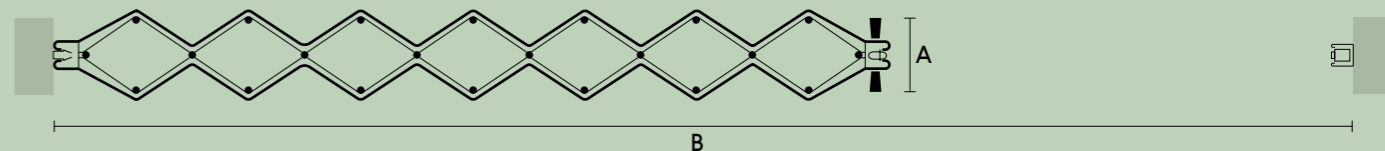

### Ingombro porta raccolta Overall dimensions of folded door

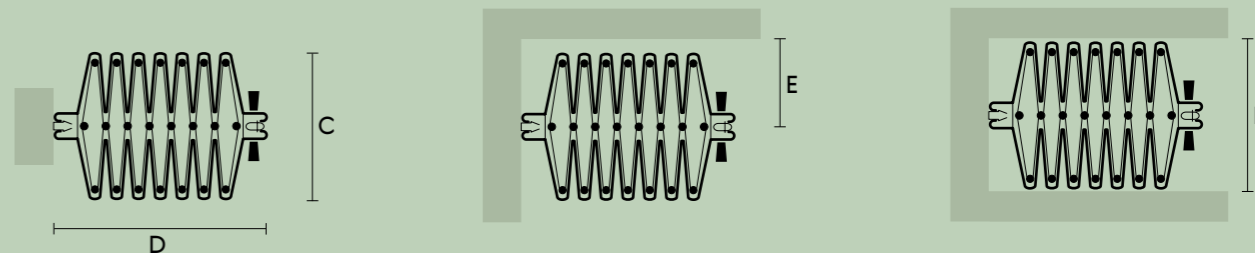

A → 180 mm  
B → larghezza del vano  
C → da 220 a 240 mm  
D → 20% di B (con blocco)  
30% di B (senza blocco)  
E → 130 mm  
F → 260-300 mm

A → 180 mm  
B → width of the compartment  
C → from 220 to 240 mm  
D → 20% of B (with block)  
30% of B (without block)  
E → 130 mm  
F → 260-300 mm

## Guida superiore

La guida superiore in alluminio è la componente strutturale della porta tessile Door che ne permette lo scorrimento e al tempo stesso la sostiene. Questo elemento può essere a vista (visibile a porta raccolta), oppure incassato se si mimetizza con il soffitto per offrire un migliore impatto estetico.

La guida è frutto di una tecnologia che, grazie a perni in acciaio ed elementi di giunzione che collegano più pezzi, permette una lunghezza potenzialmente infinita. La precisione dell'allineamento conferisce fluidità al movimento.

Esistono 3 tipi di guide: standard, regolabile e da incasso.

La guida standard è di piccole dimensioni ed è dotata di spigoli arrotondati che ne addolciscono la forma e può essere installata in modalità a vista.

La guida regolabile può avere un'altezza regolabile (0-24 mm) utilizzata per soddisfare esigenze di fuori squadra e può essere installata in modalità a vista. È formata da una cover e dalla guida standard all'interno accoppiate insieme tramite regolatori e viti di fissaggio. La regolazione è consentita attraverso delle viti di regolazione fornite in tre diverse misure.

La guida da incasso è dotata di alette laterali per l'inserimento all'interno del contro soffitto. È formata da una cover e dalla guida standard all'interno accoppiate insieme per il tramite di regolatori e viti di fissaggio. Per questo tipo di guida non è possibile la regolazione.

## Guida standard

Installazione a vista. Il rivestimento copre la guida quando la porta è distesa.

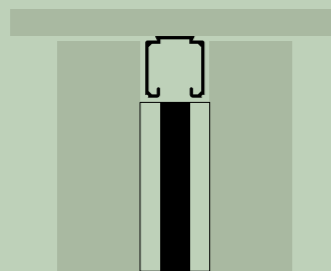
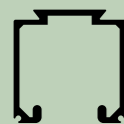

29x29 mm

## Upper track

The aluminium track is the structural component of the Door folding door that allows it to slide and at the same time supports it. This element may be visible (when the door is folded) or built-in to blend into the ceiling for improved appearance.

The track is the outcome of a technology in which steel pivots connect multiple modules, permitting potentially infinite length. The accuracy of this alignment adds fluidity to its movement.

There are three kinds of track: standard, adjustable and built-in.

The standard track is small, with rounded corners for a softer shape and can be installed for the visible mode.

The adjustable track is adaptable in height (0-24 mm) to meet out-of-square requirements and can be installed for the visible mode. It consists of external cover and internal standard track, coupled together by means of adjusters and fixing screws. Regulation is performed by means of adjustment screws supplied in three different sizes.

The built-in track is equipped with side flaps for insertion inside the false ceiling. It consists of external cover and internal standard track, coupled together by means of adjusters and fixing screws. Adjustment is not possible for this type of track.

## Standard track

Installation with visible mode. The cladding covers the track when the folding door is fully extended.

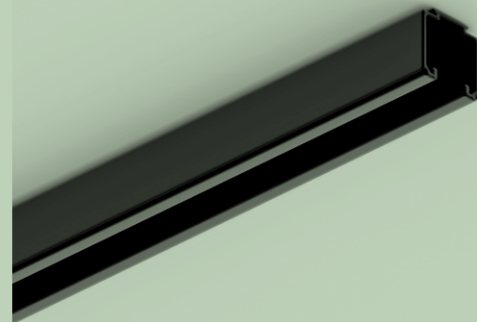

## Guida superiore

### Guida regolabile

Installazione a vista. Compensando eventuali fuorisquadro si scopre una porzione di guida pari alla misura da compensare.

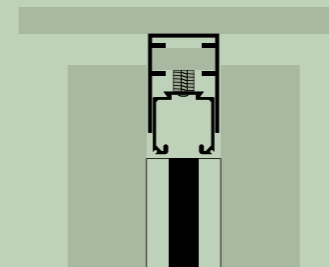
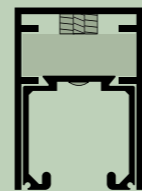

33x46 mm

## Upper track

### Adjustable track

Installation with visible mode. In the presence of out-of-square spots to be compensated, the adjustment will cause a part of the track to be uncovered, equal to the height difference to be compensated.

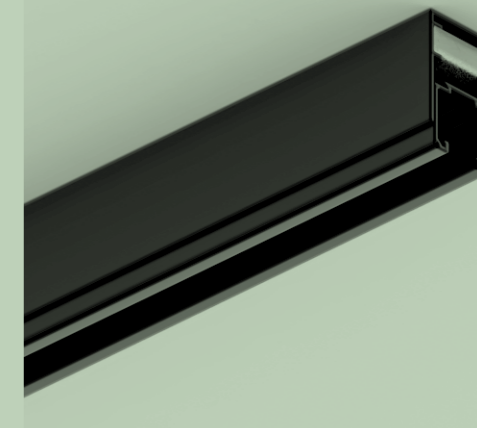

## Guida da incasso

Installazione incassata.

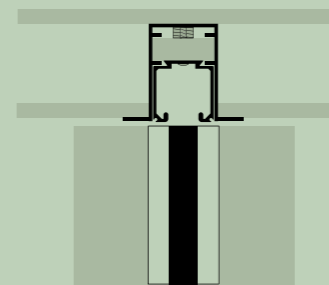
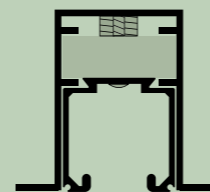

45x46 mm

## Built-in track

Built-in installation.

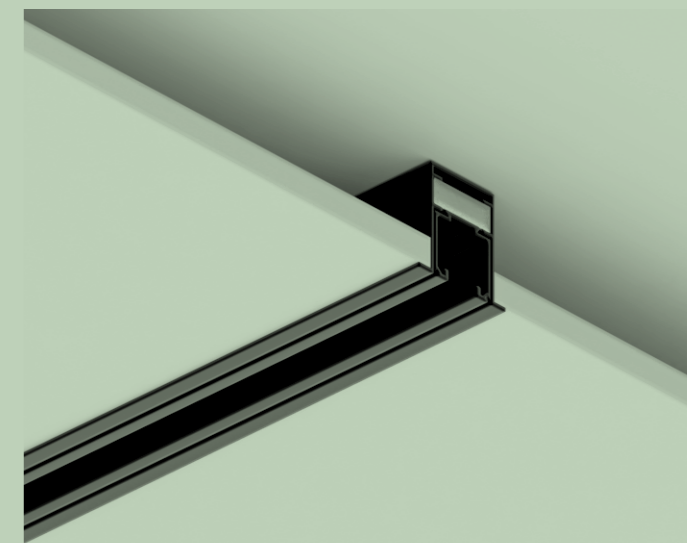

## Guida superiore

Le guide possono essere curvate (con un raggio di curvatura minimo di 600 mm e con una porzione curva che corrisponde ad un angolo da 90°), rendendo sinuosa la silhouette della porta. Esistono vari esempi di curvatura: i raggi standard sono 600 mm — 800 mm — 1000 mm, ma è possibile anche realizzare raggi custom su progetto.

### Curva singola Single curve

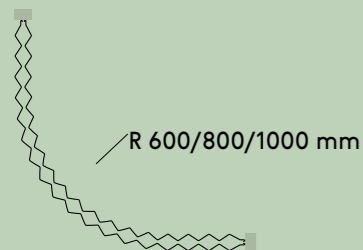

### Curva circolare Circular curve

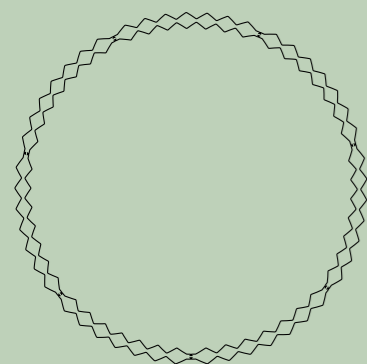

### Doppia curva Double curve



## Upper track

The tracks can be curved (with a minimum radius of curvature of 600 mm and a curved portion corresponding to a 90° angle), making the silhouette of the door sinuous. There are various examples of curvature: standard radii are 600 mm — 800 mm — 1000 mm, but it is also possible to customize radii based on the project.

### Doppia curva a S S-shaped double curve

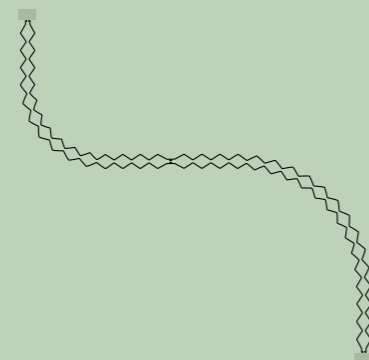

### Quattro curve Four curves

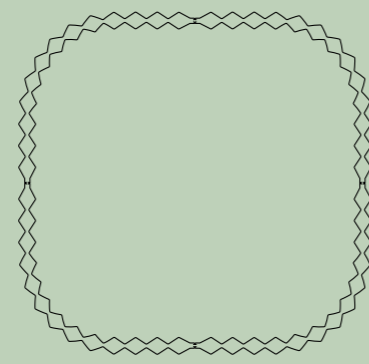

## Sistemi di apertura

Compatibili sia con guide lineari che curve, i sistemi di apertura delle porte tessili Door sono progettati per permettere diverse configurazioni dell'ambiente.

Gli spazi di piccole dimensioni e larghezza contenuta prediligono porte con apertura laterale.

L'apertura bilaterale permette di sfruttare lo spazio nella sua totalità, grazie al caratteristico doppio passaggio.

L'apertura centrale centrata si presta per ambienti molto ampi e ha il compito di creare un punto di passaggio centrale, dove i due elementi laterali completano il quadro, facendo da cornice a tutto l'insieme.

L'apertura centrale decentrata è la risposta a un'esigenza specifica, richiesta in base allo spazio in cui viene inserita, che varia in base alle necessità.

L'apertura multipla garantisce massima versatilità e funzionalità: è studiata per essere complementare a tutti i sistemi precedentemente descritti. Negli spazi di grandi dimensioni ha un duplice compito: dare il giusto equilibrio a ciascun elemento e ampliarne la fruibilità. Se applicata agli armadi, permette l'utilizzo del 100% della capienza.

### Apertura laterale lineare Linear lateral opening



## Opening systems

Compatible with both linear and curved tracks, Door textile door opening systems are designed to enable a wide range of spatial configurations.

Small and narrow spaces are best suited to lateral opening doors.

Bilateral opening allows you to make use of the whole space, with its characteristic double passage.

Centred central opening is appropriate for large rooms, creating a central passageway. Two side elements complete the picture, framing the whole.

A decentred central opening responds to specific needs of the space where it is installed, which may vary according to requirements.

Multiple opening permits maximum versatility and practicality, designed to complement all the systems described above. In large spaces it plays two roles, giving each element the right balance and amplifying its usability. When used for wardrobes, it enables 100% of their storage capacity to be utilised.

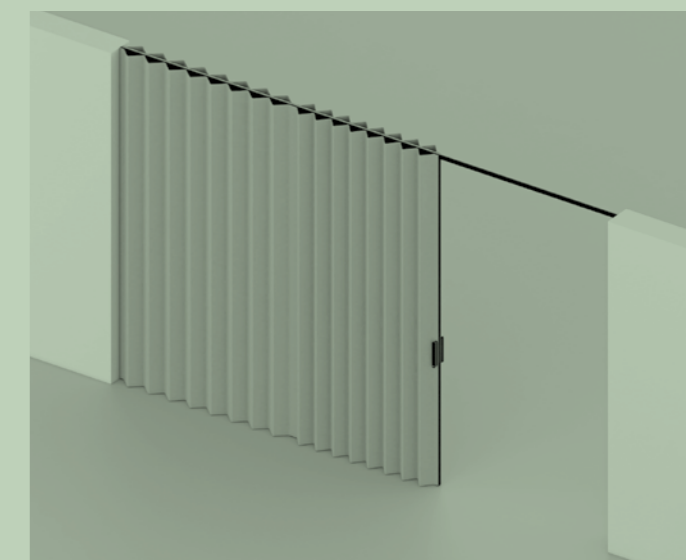

**Apertura laterale curva**  
Curved lateral opening

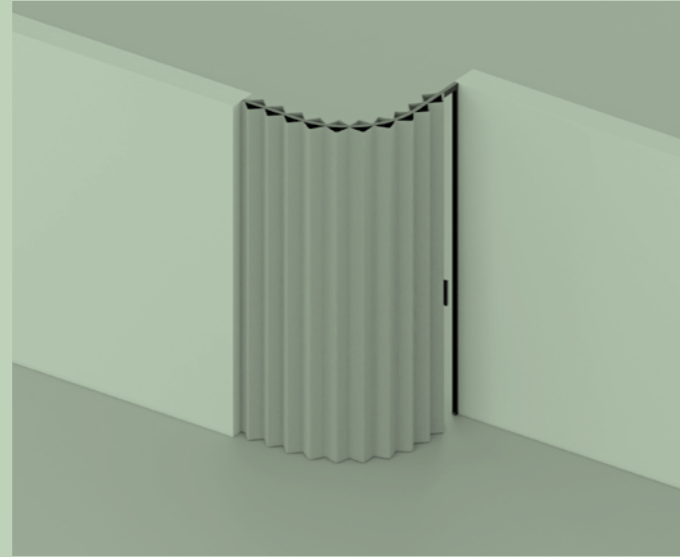
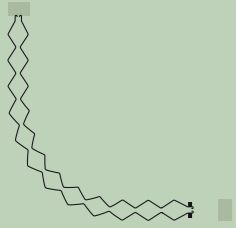

**Apertura bilaterale lineare**  
Linear bilateral opening

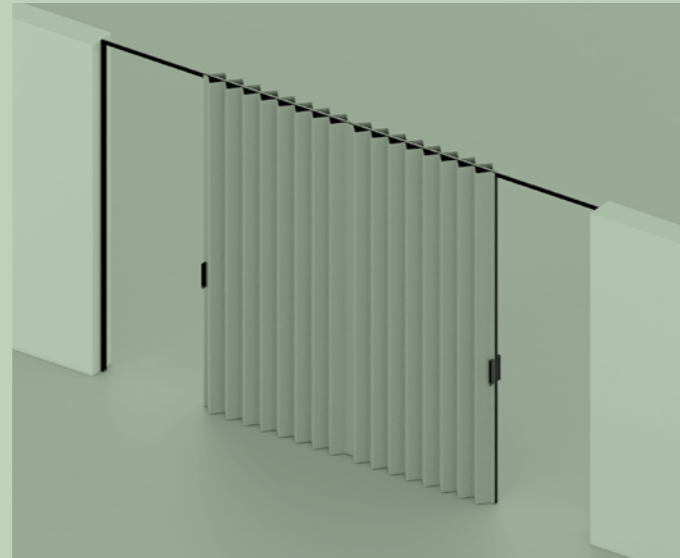
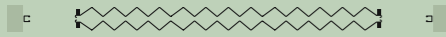

**Apertura bilaterale curva**  
Curved bilateral opening

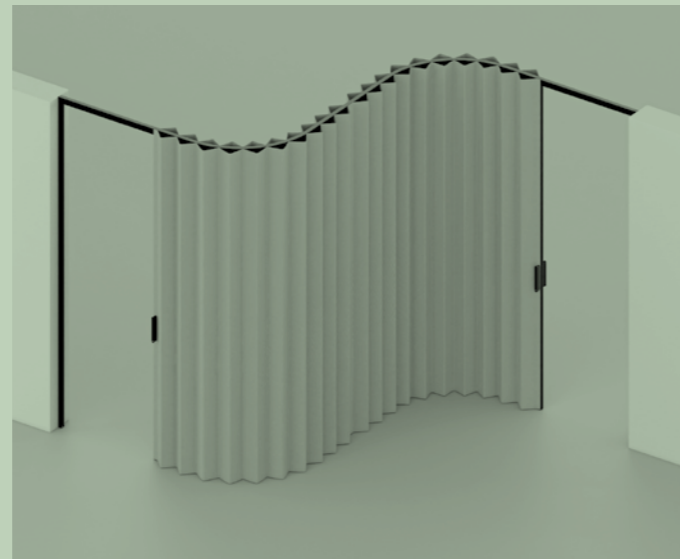
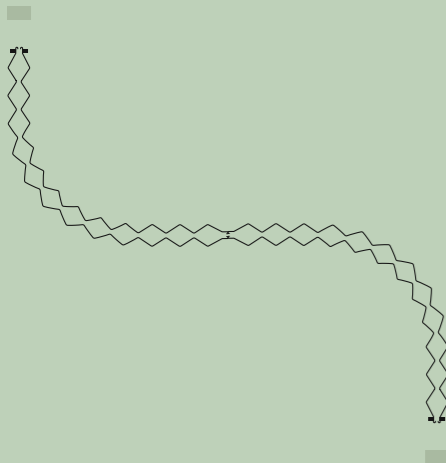

**Apertura centrale lineare**  
Linear central opening

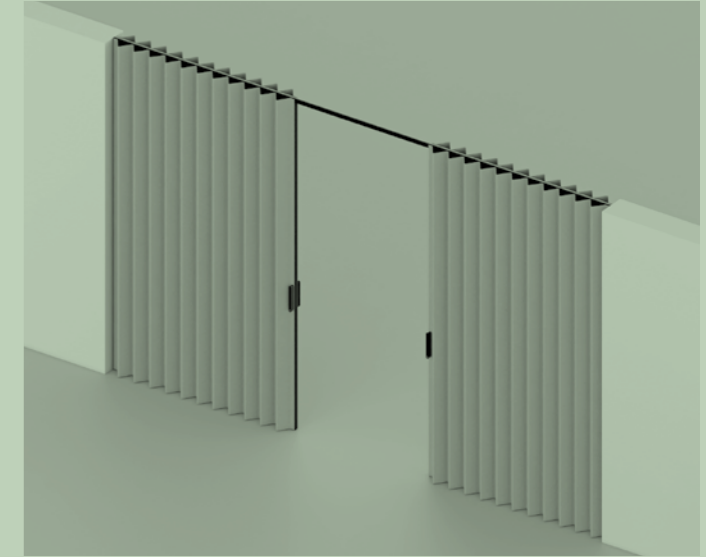

**Apertura centrale curva**  
Curved central opening

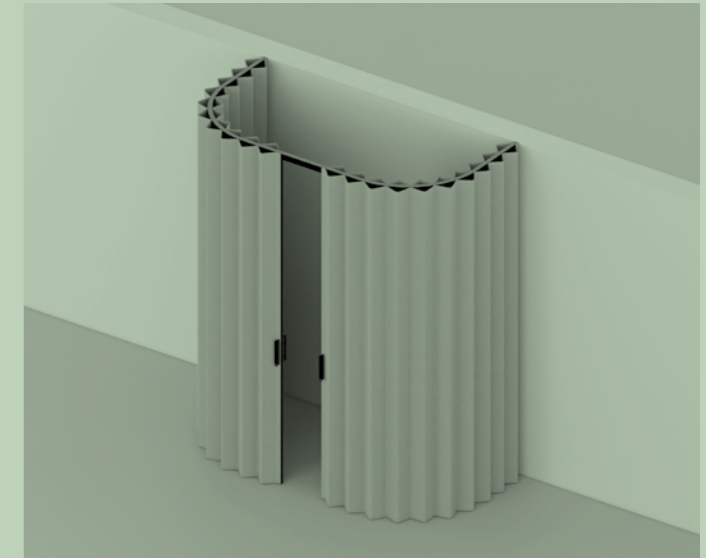
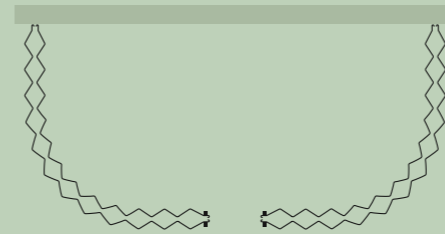

**Apertura decentrata lineare**  
Linear decentred opening

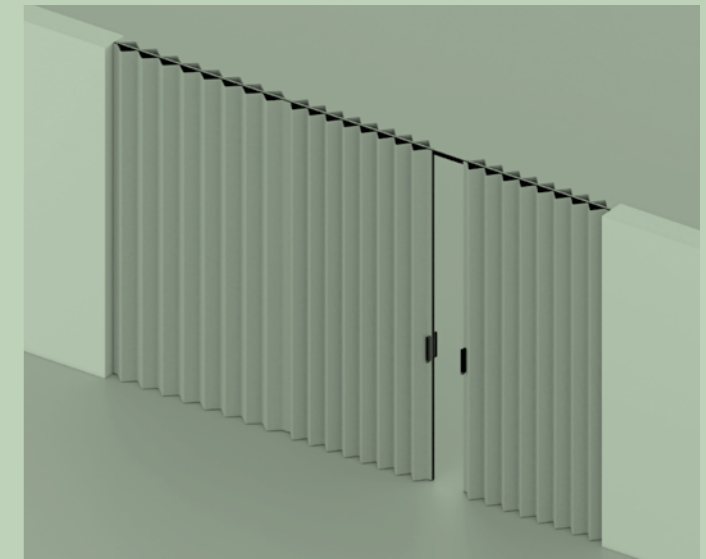
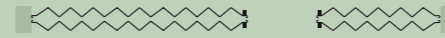

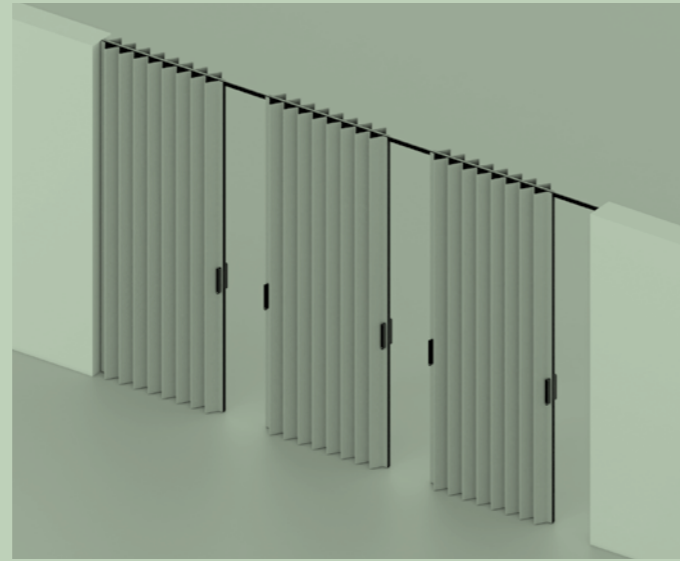
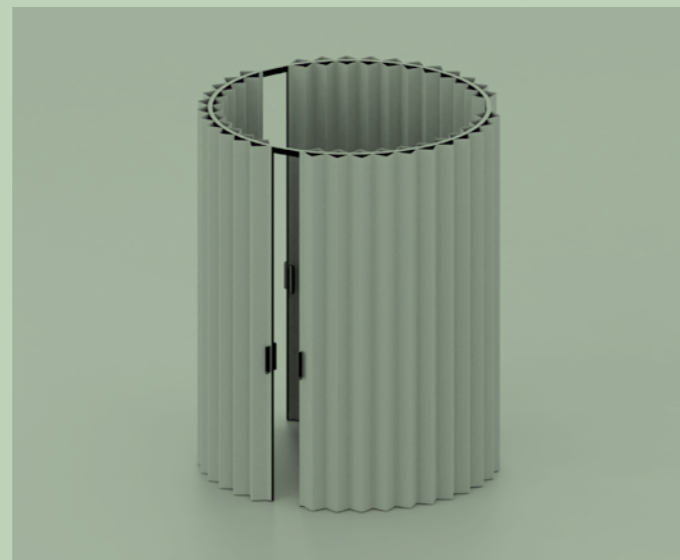
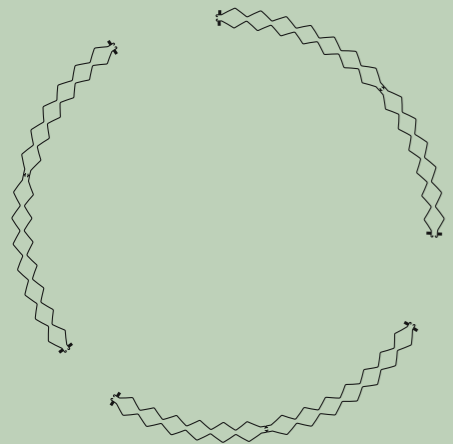
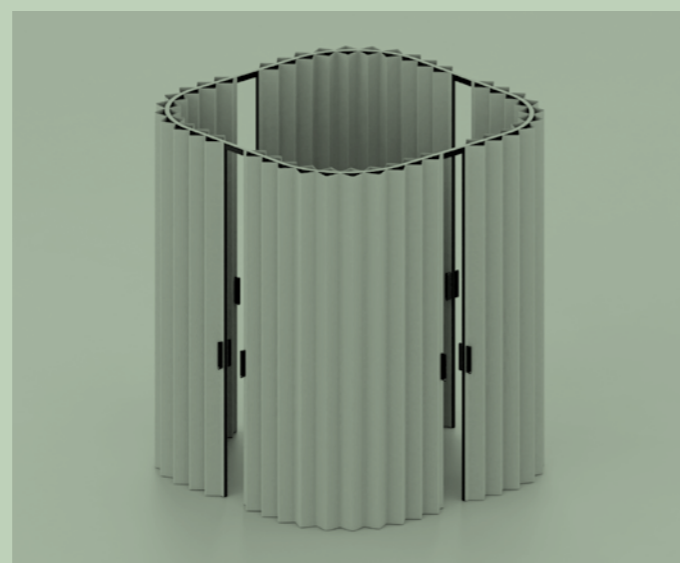
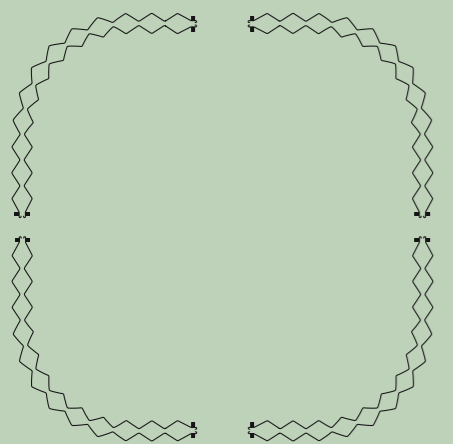
**Apertura multipla lineare**  
 Linear multiple opening

**Apertura circolare multipla**  
 Circular multiple opening

**Apertura multipla curva**  
 Curved multiple opening

Due le opzioni per i sistemi di chiusura delle porte tessili Door: magnetica e meccanica.

I sistemi di chiusura magnetica rappresentano la sintesi di rigore, minimalismo, eleganza e funzionalità. Possono essere forniti in tre versioni: con profilo di battuta in alluminio, con barra piatta in ferro a tutta altezza e con calamite incassate.

Il sistema di chiusura magnetica con profilo di battuta a parete, contenente le calamite, combinato con la guida visibile, crea una cornice che assicura continuità dal punto di vista estetico.

Nel sistema di chiusura magnetica con barra piatta in ferro a tutta altezza, quest'ultima va installata a parete e può essere fornita con e senza fori. Se installata a vista, crea un leggero segno verticale nella parete; se incassata nel muro (arretrata per un massimo di 2 mm), crea un risultato estetico più leggero.

Il sistema di chiusura magnetica con calamite incassate a parete (arretrate per un massimo di 2 mm), combinato con la guida da incasso, è ideale per ottenere delle forme pulite che diventano massima espressione di minimalismo. In caso di apertura centrale, questo è il sistema di chiusura predefinito.

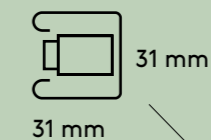
**Sistema di chiusura magnetica con profilo di battuta**  
 Magnetic closing system with profile

The closing systems of Door folding doors have two possible options: magnetic and mechanical.

The magnetic closing systems represent a combination of accuracy, minimalism, elegance and practicality. Three closing options are available: with aluminium profile, with vertical flat iron bar and with built-in magnets.

The magnetic closing system with wall-mounted profile containing the magnets, combined with the visible track, creates a frame guaranteeing aesthetic continuity.

In the magnetic closing system with vertical flat iron bar, the latter is wall-mounted and available with or without pre-drilled holes. When surface-mounted, it creates a slight vertical mark on the wall; when recessed (to a maximum depth of 2 mm), it achieves a lighter aesthetic result.

The magnetic closing system with built-in magnets (set back by max 2 mm), combined with the built-in track, is perfect for creating clean lines, the utmost expression of the minimalist aesthetic. This is the default closing system for doors with central opening.

Sistema di chiusura magnetica con barra piatta in ferro  
Magnetic closing system with vertical flat iron bar

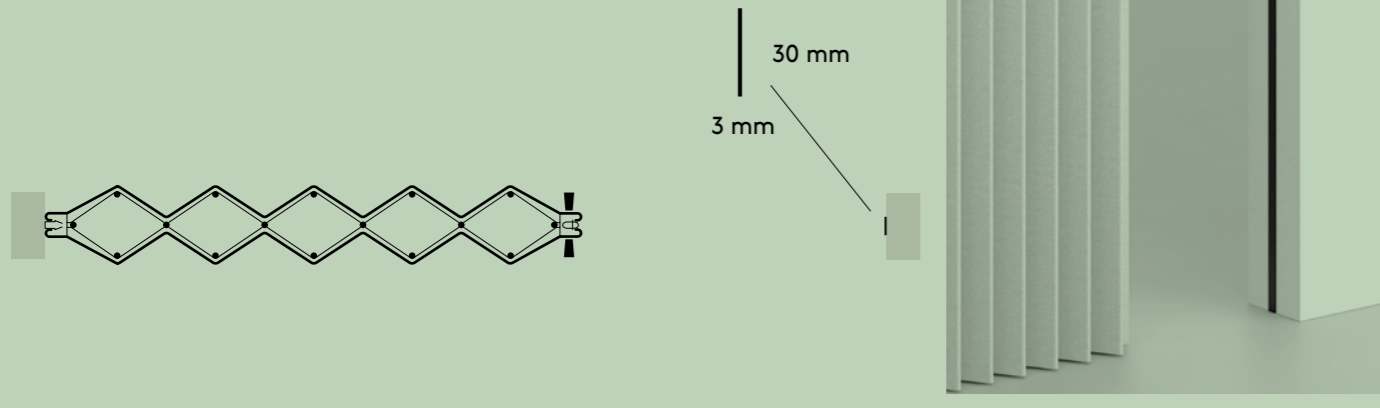

Sistema di chiusura magnetica con calamite incassate  
Magnetic closing system with built-in magnets

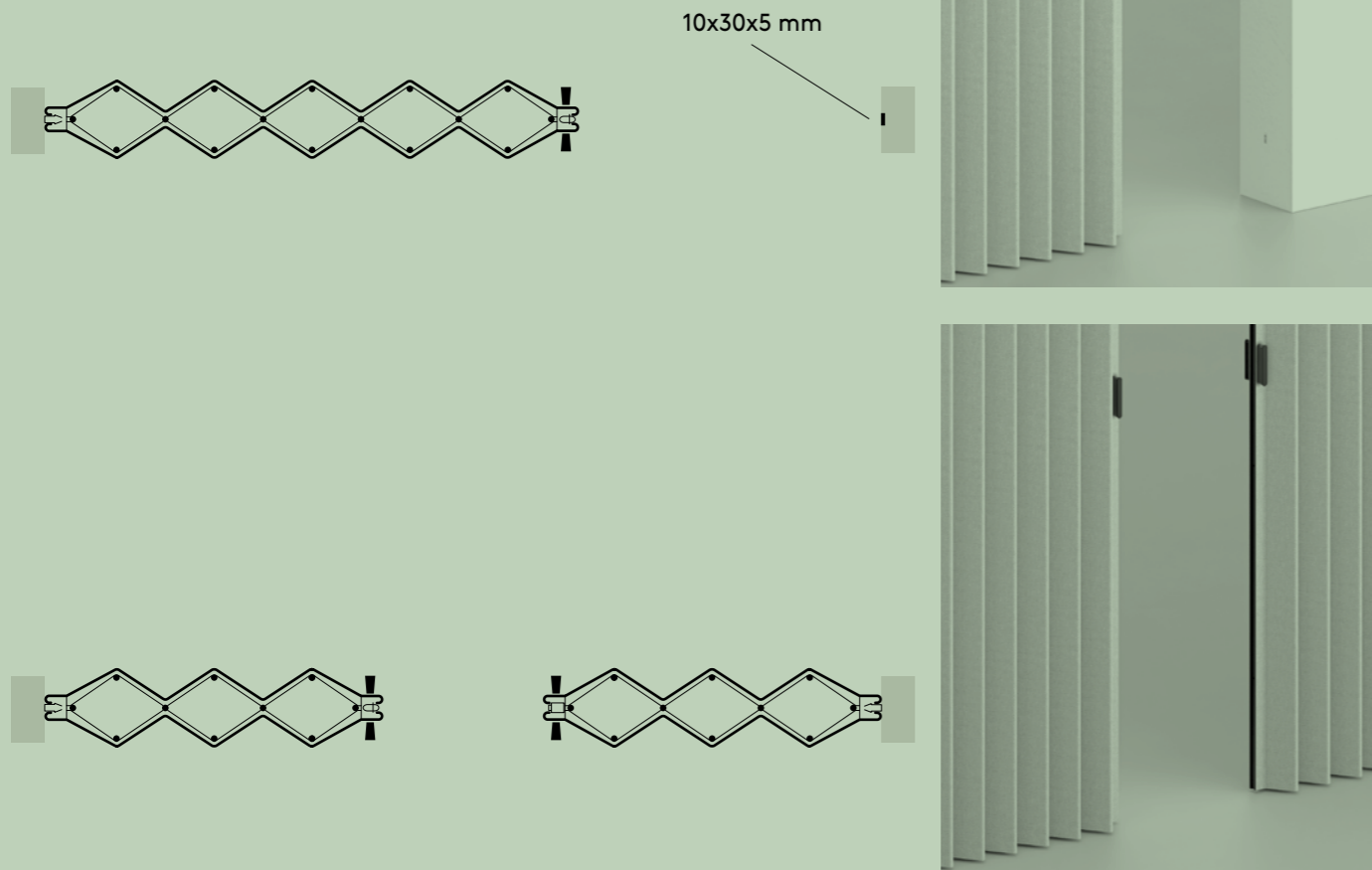

I sistemi di chiusura meccanica garantiscono maggior sicurezza nella chiusura e possono essere forniti in due versioni: con scrochetto e con scrochetto e serratura (cilindro Europeo), entrambe corredate di profilo di battuta in alluminio. Abbinati all'apertura centrale i sistemi di chiusura meccanica prevedono un profilo di battuta (non rivestito) al centro.

Mechanical closing systems provide greater locking security and can be supplied in two versions: with a latch and with a latch and lock (European cylinder). Both versions are coupled with the aluminium profile. In combination with the central opening, mechanical closing systems are coupled with an uncladded profile in the centre.

Sistema di chiusura meccanica con scrochetto e profilo verticale  
Mechanical closing system with latch and vertical profile

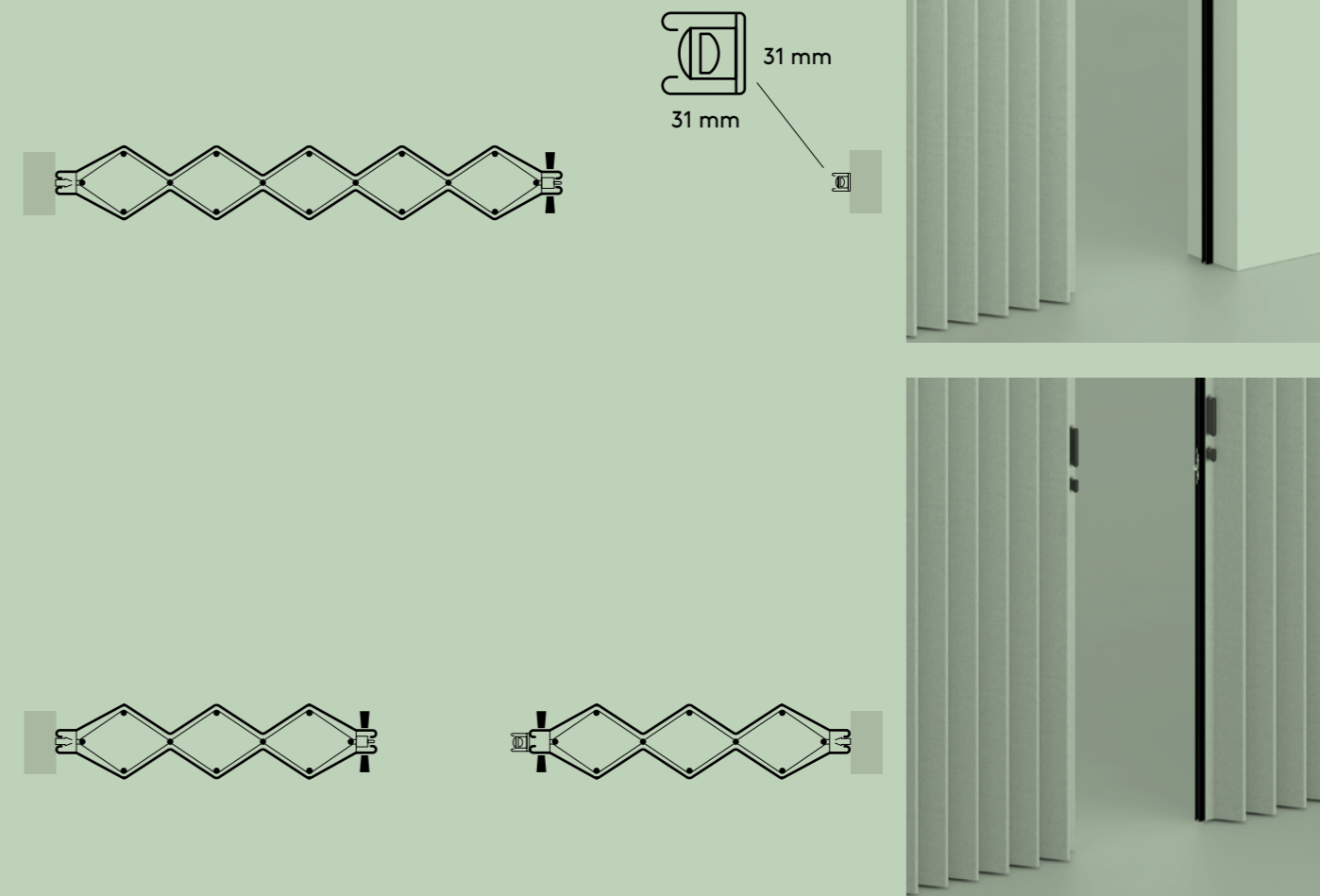

Sistema di chiusura meccanica con scrochetto e serratura (cilindro Europeo) e profilo verticale  
 Mechanical closing system with latch and lock (European cylinder) and vertical profile

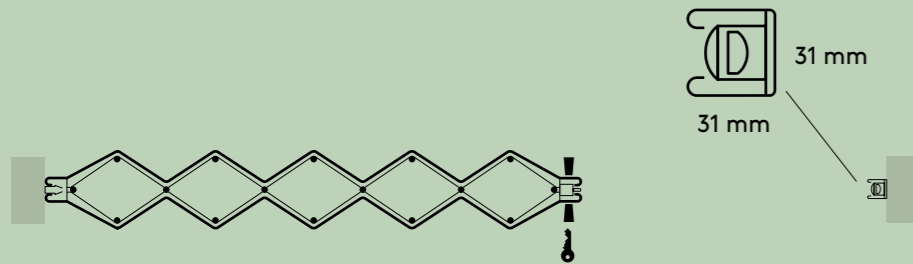

La maniglia Door è un raffinato accessorio che esalta la funzionalità della porta tessile, soprattutto quando viene movimentata, ed è il risultato di un'attenta ricerca ergonomica ed estetica.

La porta tessile Door con sistema di apertura magnetica può essere fornita anche senza la maniglia e movimentata attraverso una delle sue pieghe. Questa configurazione è consigliata unicamente se la porta è rivestita con materiali tecnici, più resistenti, quali le ecopelli.

Nel caso di sistema di chiusura meccanica, la maniglia è necessaria per la rotazione dello scrochetto, possibile solo con i modelli CB#4 e CB#5.

The Door handle is the result of in-depth ergonomics and aesthetic research, an elegant accessory underlining the folding door's practicality, especially when in motion.

The Door textile door with magnetic opening system can also be supplied without the handle and moved by clasping one of its folds. This configuration is only recommended if the door is covered with technical, more resistant materials such as eco-leather.

In the case of a mechanical closing system, the handle is necessary for the rotation of the latch, possible solely with models CB#4 and CB#5.

CB#1

75x25x300 mm



CB#2

29x18x216 mm



CB#3

29x18x130 mm



CB#4  
(CB#3+CB#5)

29x18x216 mm



CB#5

29x18x43 mm



La porta tessile Door viene proposta con un'ampia gamma di rivestimenti e diventa elemento di grande carattere, protagonista dello spazio in cui è inserita, se realizzata con un tessuto altamente distintivo.

The Door folding door is available with a vast range of cladding materials and becomes an element of great character that will stand out in the space where it is installed if clad with decorative fabrics.

È invece un'elegante vibrazione, se rivestita con materiali o tessuti opachi, simili alle pareti con le quali si mimetizza.

If clad with matt fabrics or materials, similar to the surrounding walls, it blends into them and becomes a subtly elegant echo.

I due lati della porta possono avere due rivestimenti differenti: così mentre un lato può dialogare con un ambiente moderno ed essenziale, l'altro può avere un carattere completamente differente.

The door may be clad in different materials on each side: so while one side may be in keeping with a modern, minimalist space, the other may have a completely different feel and look.

**Lato destro**  
Right side

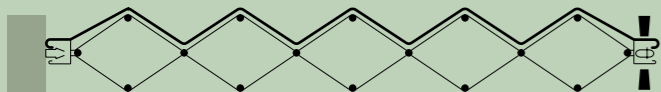

**Lato sinistro**  
Left side

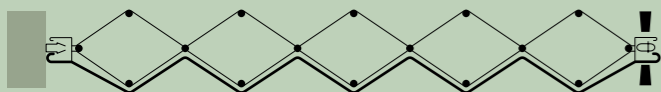

**Guarnizione verticale di rifinitura in gomma**  
Vertical rubber finishing seal

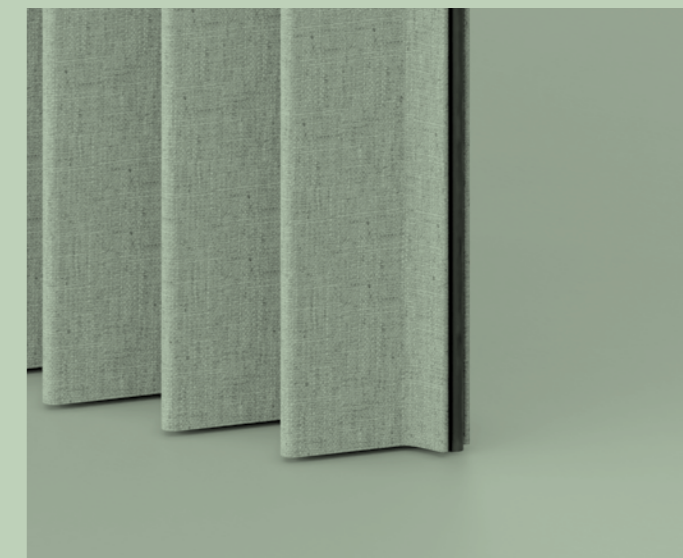

**Sistema di aggancio meccanico a parete con molle in acciaio**  
Wall-mounted mechanical coupling system with steel springs

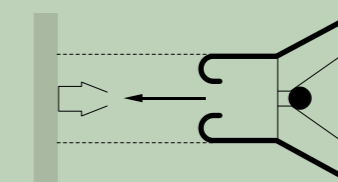
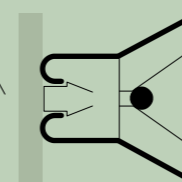
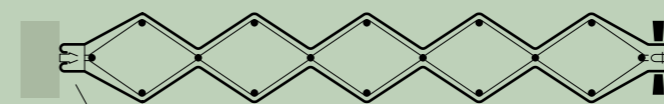

**Sistema di aggancio meccanico tra moduli con molle in acciaio**  
Inter-module mechanical coupling system with steel springs

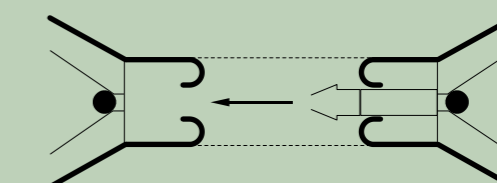
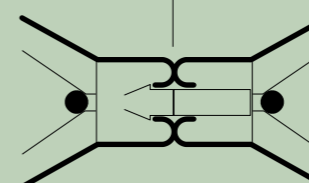
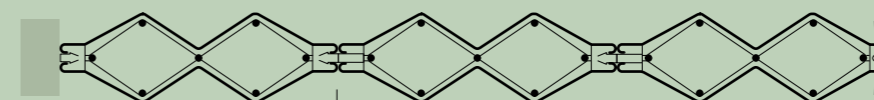

## Blocco magnetico interno

## Internal magnetic block

Al fine di ridurre l'ingombro e aumentarne l'apertura, la porta tessile può essere dotata di un sistema di blocco magnetico interno che tiene la porta raccolta al massimo. È possibile inserire questo accessorio nei moduli con larghezza di costruzione fino a 2420 mm. In caso di guida curva non è possibile utilizzare questo accessorio.

In order to reduce the overall dimensions and increase its opening, the textile door can be fitted with an internal magnetic block that holds the folded door firmly together. It is possible to fit this accessory in modules with a maximum width of 2420 mm. In the case of curved tracks, this accessory cannot be used.

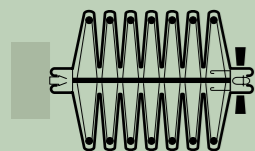

## Blocco meccanico interno

## Internal mechanical block

Al fine di bloccare la porta in una determinata posizione, è possibile richiedere un sistema di blocco meccanico integrato nel profilo interno e azionato mediante una chiave a brugola. Tale accessorio può sopperire all'assenza del blocco magnetico ed essere utilizzato anche per ridurre l'ingombro e tenere la porta compattata in presenza di guida curva. Nei casi in cui la porta non arriva a parete, occorre prevedere l'inserimento aggiuntivo nella guida superiore di un fermo porta che eviti la fuoriuscita del modulo e chiuda la guida.

To secure the door in a fixed position, a mechanical blocking system integrated within the internal profile and operated via an Allen key is available upon request. This accessory can substitute for the magnetic block and is also used to minimize the overall dimensions, keeping the door compacted in case of curved tracks. In configurations where the door does not terminate at a wall, an additional stopper must be installed in the upper track to prevent the module from sliding out and to provide a clean finish to the track end.

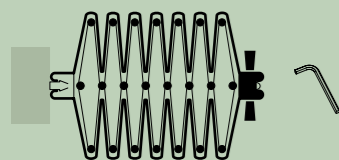

## Montante mobile di battuta

## Sliding locking post

Questo accessorio è un elemento esterno in ferro verniciato a sezione quadrata dotato di un carrello che scorre nella guida superiore. Bloccato meccanicamente in posizione mediante una chiave a brugola, il montante fornisce una battuta mobile e consente una chiusura magnetica della porta nel punto desiderato anche in assenza di parete. Nei casi in cui la porta non arriva a parete, occorre prevedere l'inserimento aggiuntivo nella guida superiore di un fermo porta che eviti la fuoriuscita del modulo e chiuda la guida.

This accessory consists of an external powder-coated iron element with a square section, equipped with runners that slide within the upper track. Mechanically locked in position via an Allen key, the locking post provides a movable stop and enables magnetic closure of the door at any desired point, even in the absence of a wall. In configurations where the door does not terminate at a wall, an additional stopper must be installed in the upper track to prevent the module from sliding out and to provide a clean finish to the track end.

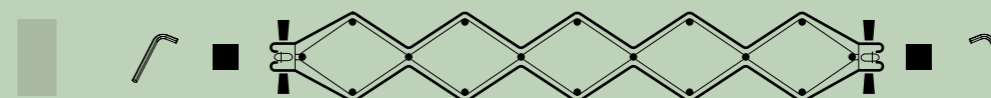
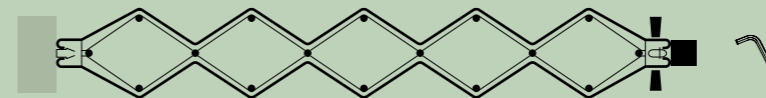

Le porte tessili Door possono essere progettate per rispondere a svariate esigenze di configurazione attraverso sistemi di unione di due tipi: con profili integrati o con montante mobile di battuta. Entrambe le tipologie sono declinabili per sistemi a L, a T e a X.

Door textile doors can be engineered to meet diverse configuration requirements through two types of joining systems: with integrated profiles or with a sliding locking post. Both options are available for L-shaped, T-shaped, and X-shaped systems.

Sistema a L con profili integrati  
L-shaped system with integrated profiles

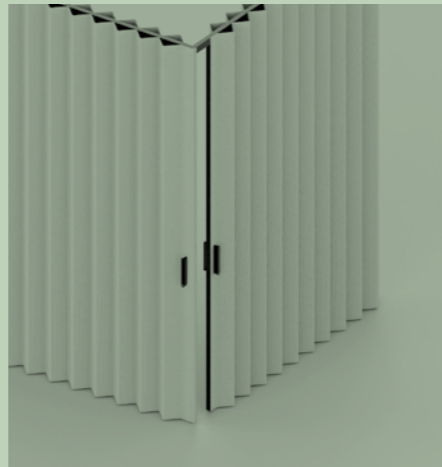
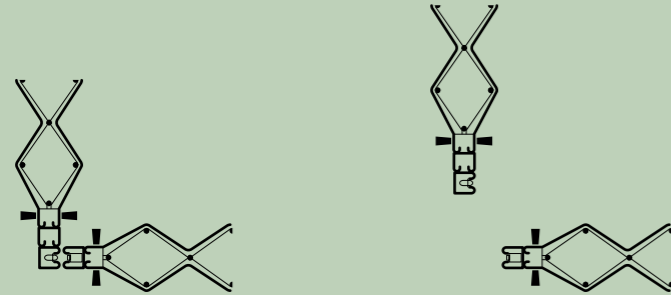

Sistema a T con profili integrati  
T-shaped system with integrated profiles

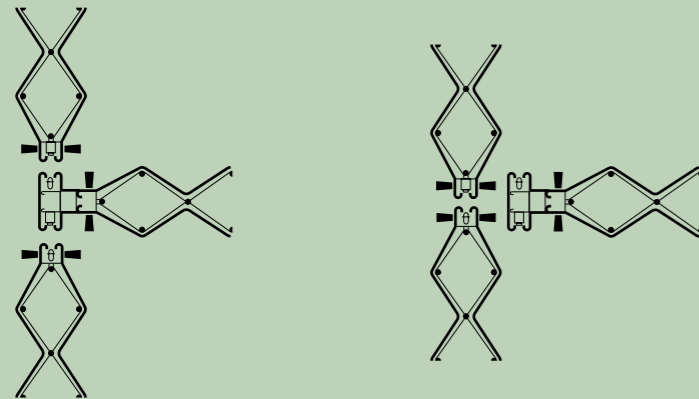

Sistema a X con profili integrati  
X-shaped system with integrated profiles

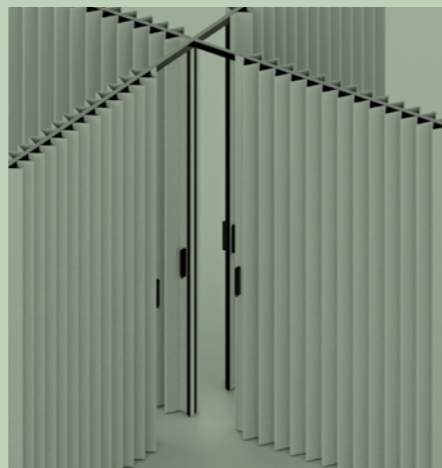
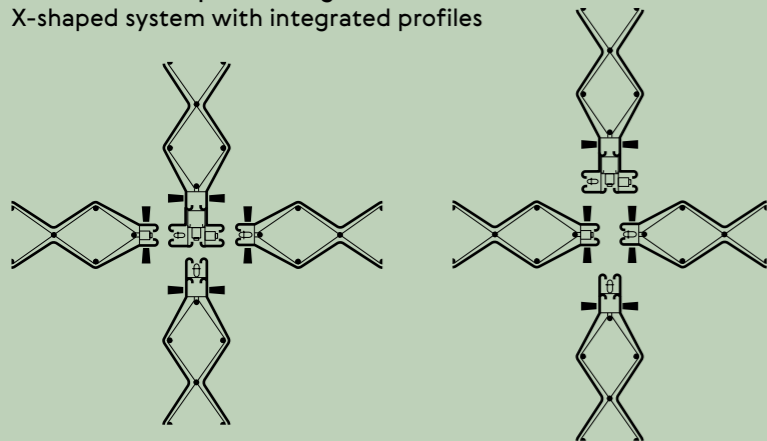

Sistema a L con montante mobile di battuta  
L-shaped system with sliding locking post

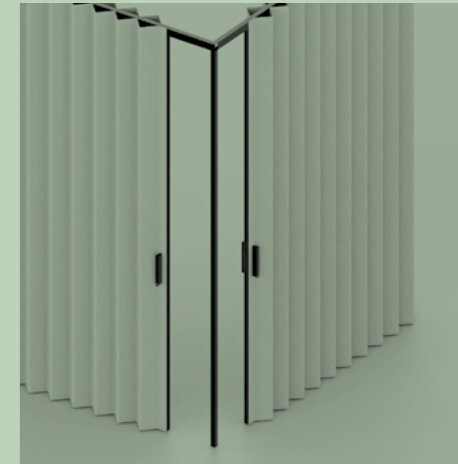
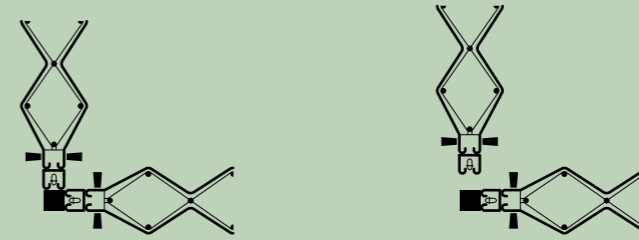

Sistema a T con montante mobile di battuta  
T-shaped system with sliding locking post

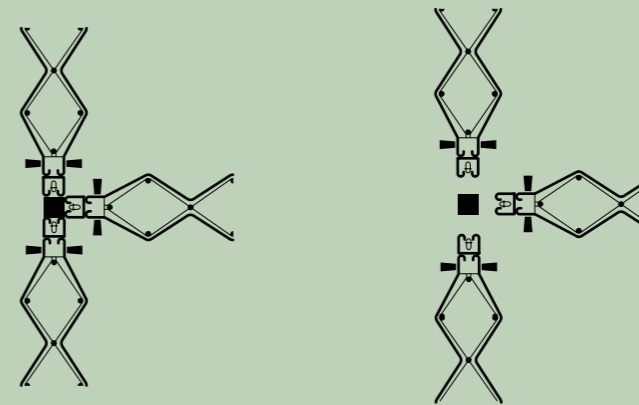

Sistema a X con montante mobile di battuta  
X-shaped system with sliding locking post

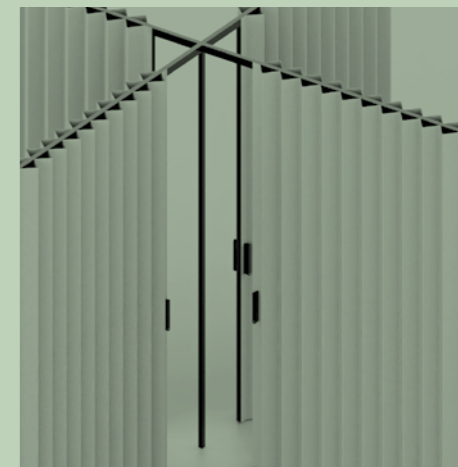
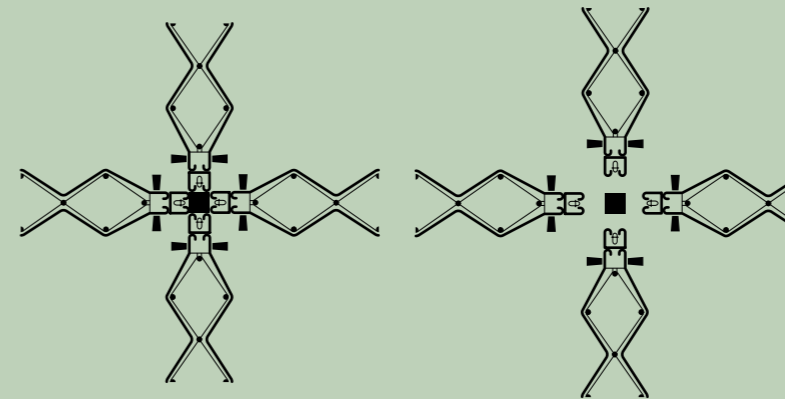

Varianti colore Colour variations

Varianti colore di guide e profili di battuta Colour variations of tracks and profiles

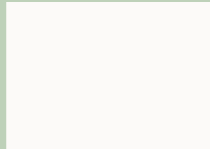
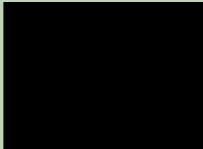
Alluminio ossidato satinato Satin oxidised aluminium		Bianco semilucido RAL 9010 Semigloss white RAL 9010		Nero opaco RAL 9005 Matt black RAL 9005	
---	---	--	---	--	---

Varianti colore di barra piatta in ferro a tutt'altezza Colour variations of vertical iron bar

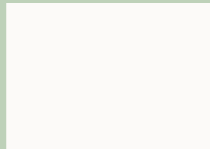
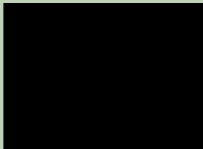
Alluminio verniciato satinato Satin-finish painted aluminium		Bianco semilucido RAL 9010 Semigloss white RAL 9010		Nero opaco RAL 9005 Matt black RAL 9005	
---	--	--	--	--	--

Nota: colori RAL disponibili su richiesta per le parti metalliche

Note: RAL colours available on request for metallic parts

Varianti colore Colour variations

Varianti colore maniglia CB#1 Colour variations of CB#1 handle

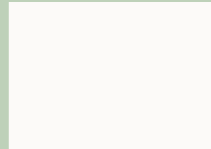
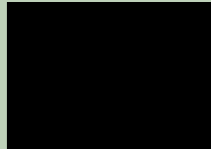
Acciaio inox satinato Satin-finish stainless steel		Bianco semilucido RAL 9010 Semigloss white RAL 9010		Nero opaco Ral 9005 Matt black RAL 9005	
---	---	--	---	--	---

Varianti colore maniglia CB#2 CB#3 CB#4 CB#5 Colour variations of CB#2 CB#3 CB#4 CB#5 handles

Alluminio verniciato satinato Satin-finish painted aluminium		Cromato lucido Polished chrome		Oro verniciato satinato Satin-finish painted gold	
Bianco semilucido RAL 9010 Semigloss white RAL 9010		Nero opaco RAL 9005 Matt black RAL 9005			

Varianti colore delle guarnizioni Colour variations of seals

Grigio freddo Cold Grey		Bianco opaco Matt white		Nero opaco Matt black	
----------------------------	---	----------------------------	---	--------------------------	---